

SYSTEM COMPONENTS

Acceval TPR-2

Tire Pressure Refill System
for Trailers and Semi-Trailers

(According to UN ECE R141 Regulation)

Control Box

Ref.: BCB2-00

- * With Pressure Booster.
- * Standard Setting: 9.2 bar.

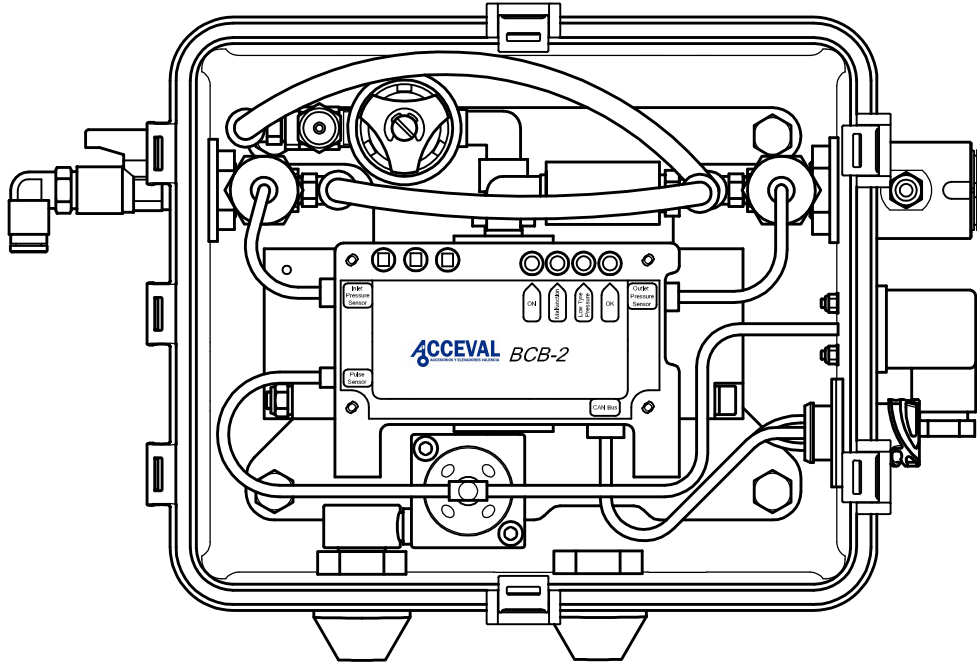

Ⓔ 10 R - 06 5119

Rotary Unions

Ref.: ROT1-00 Short - Single Wheel	Ref.: ROT2-00 Short - Double Wheel	Ref.: ROT3-00 Long - Single Wheel	Ref.: ROT4-00 Long - Double Wheel
<p>1/8-28 BSPP ≈83mm</p>	<p>1/8-28 BSPP ≈83mm</p>	<p>1/8-28 BSPP ≈153mm</p>	<p>1/8-28 BSPP ≈153mm</p>

Hoses

Ref.: LAT1-00

Elbow 90°

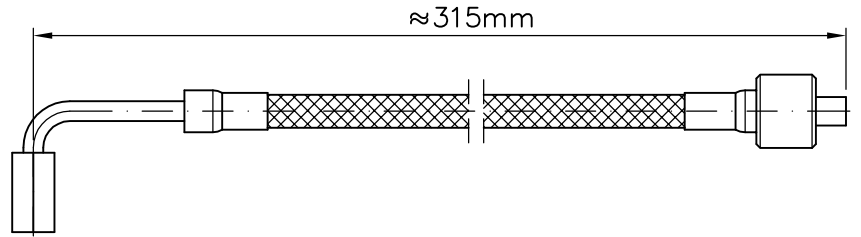

Ref.: LAT2-00

Elbow 180°

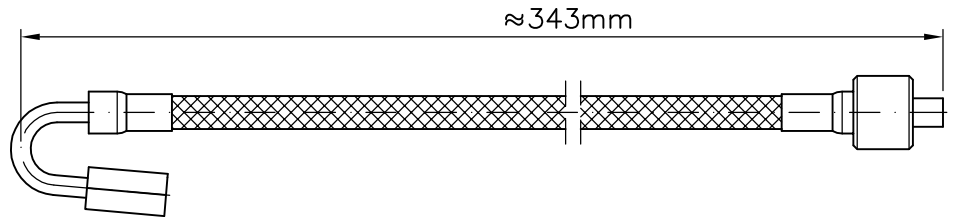

Ref.: LAT3-00

Straight

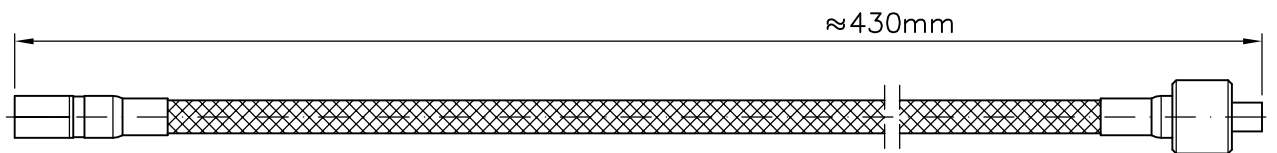

Stators

Ref.: EST1-00

Short - Air Into Axle

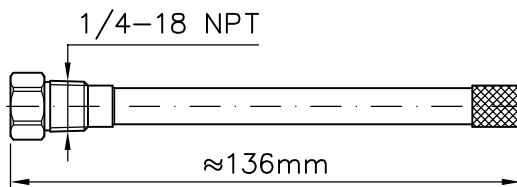

Ref.: EST2-00

Long - Air Into Axle

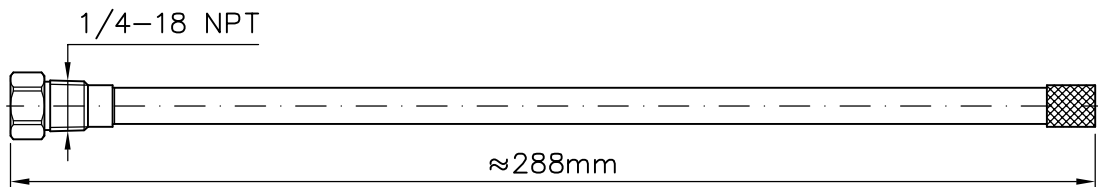

Ref.: EST3-00

Fitting - Tube (6mm) inside the axle
Hex Head

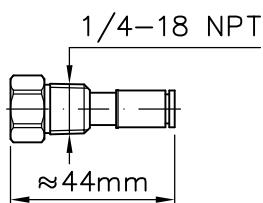

Ref.: EST4-00

Fitting - Tube (6mm) inside the axle
Round Head with Groove

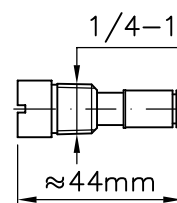

Warning Light

Ref.: LED-01

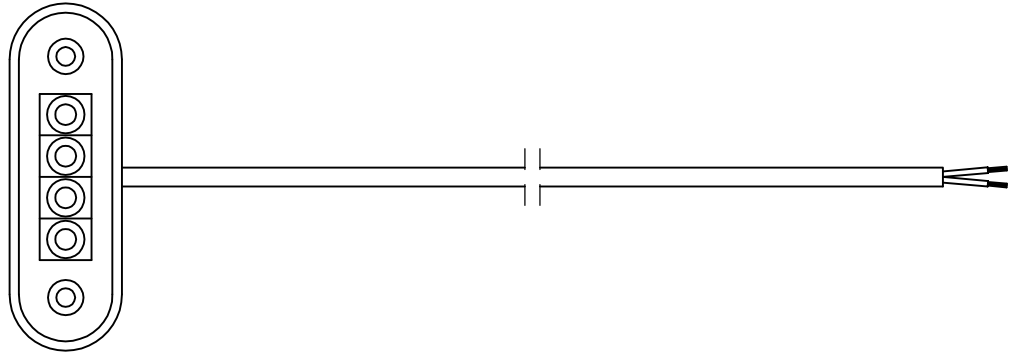

Axle Inlet Fitting

Ref.: RAC-01

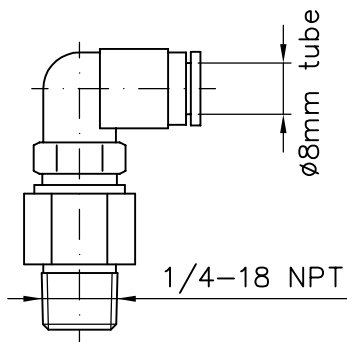

Hubcap Adapter

Ref.: ATP-01

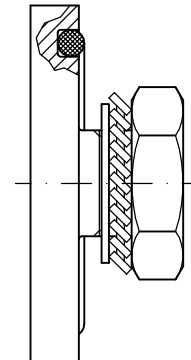

Adhesive Label

Ref.: ADH-01

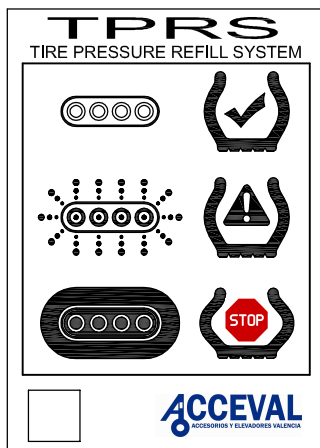



C/ Barranc Pascual, n.23
Pol. Ind. Campo Anibal
E-46530 PUZOL
Valencia - Spain

Tel. (+34) 96 141 15 18
Fax. (+34) 96 141 15 60

acceval@acceval.com
www.acceval.com